



ER BINS SKIP BINS

EASTERN recycling
Your local tip

What **SIZE** skip do I need?



- 3 Sizes - 2m³, 3m³ and 4m³
- Walk in, walk out - easy access
- Smaller sizes for domestic waste

2m³ Skip Bin.
*20 wheelbarrow loads

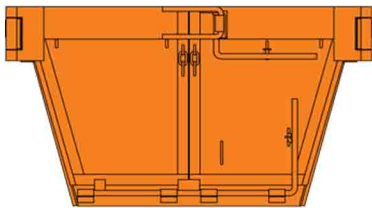

ALL ER SKIP BINS ARE THE SAME DIMENSIONS FOR 'WIDTH' AND 'HEIGHT'. ONLY THE LENGTH VARIES WHICH INCREASES THE SKIP'S CAPACITY.

INTERNALLY : 795 H
1440 W TOP &
1100 W BOTTOM

EXTERNALLY:
935 H X 1700 W

*Allow 900mm each side if you want to fold the doors back to the sides.

3m³ Skip Bin.
*30 wheelbarrow loads

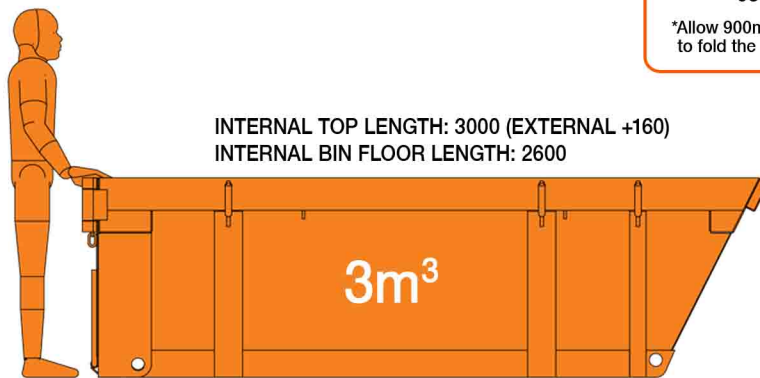
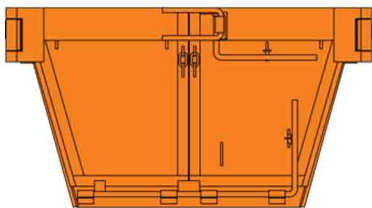

Access doors fold back to the sides

4m³ Skip Bin.
*40 wheelbarrow loads

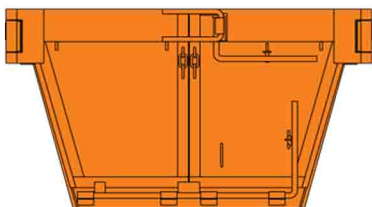

* Calculations for wheelbarrow loads are based on a large (100lt) wheelbarrow. Measurements are in millimetres (mm). Trucks require 3m width for access when unloading and loading. Bin & Skip Hire Terms & Conditions apply.



EASTERN recycling
Your local tip

ER BINS *HOOK BINS*



What **SIZE** Hook Bin do I need?

- Sizes - 6m³, 8m³, 10m³, 18m³ & 27m³
- From building renovations to commercial waste removal
- Barn doors give great access to all types of machinery

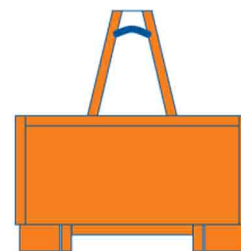
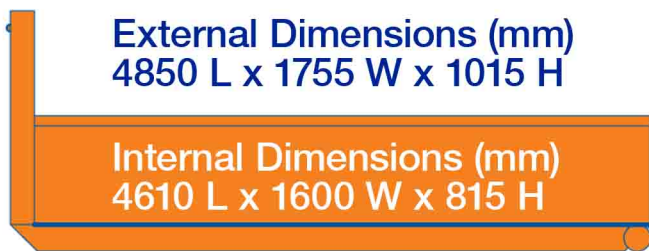

6m³

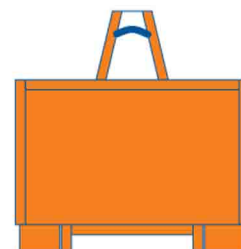

8m³

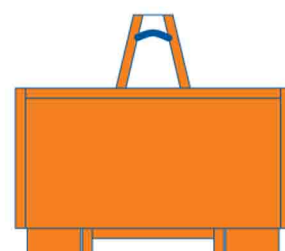
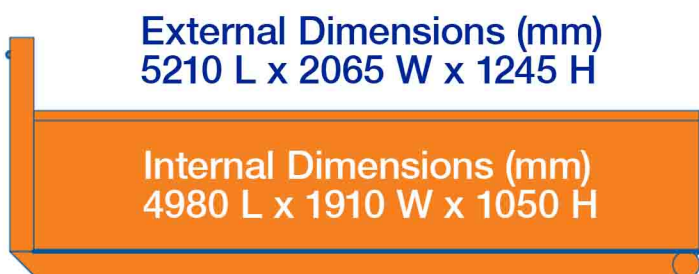

10m³



ER BINS *HOOK BINS*



What **SIZE** Hook Bin do I need?

18m³

External Dimensions (mm) - 6316 L x 2400 W x 1540 H

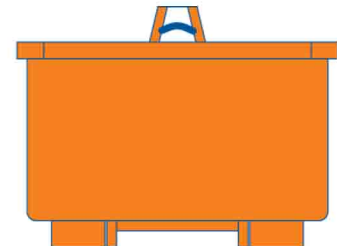
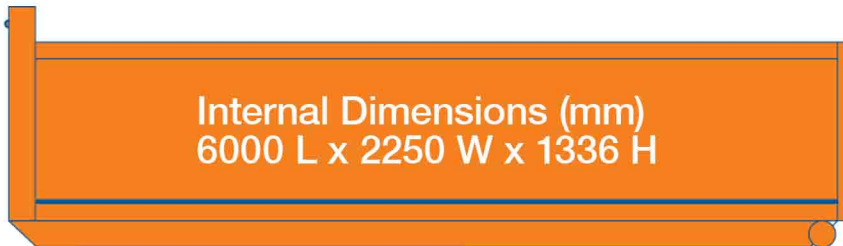

27m³

External Dimensions (mm) - 6316 L x 2400 W x 2204 H

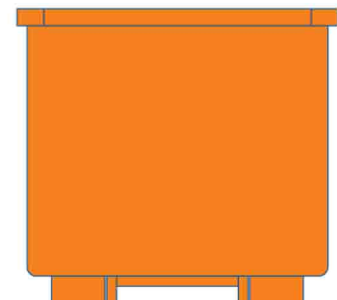
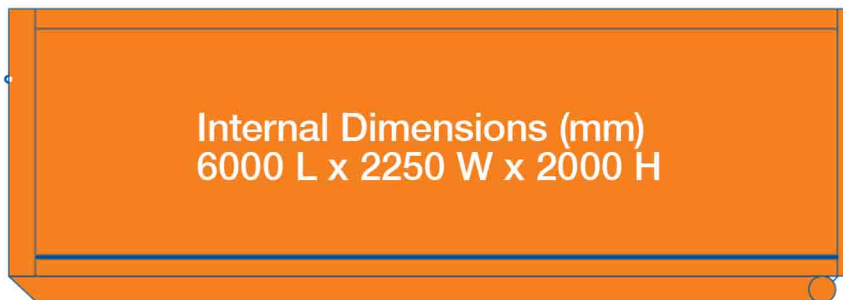

ER BINS *have been designed and manufactured for 'strength' and 'ease of use'.*

- Doors fold back to the sides
- Walk in, walk out - easy access
- Frame provides minimal ground contact - less site damage
- Easy-to-load using machinery

